

Tork Bin

50 Litre

B1

Elevation
Design

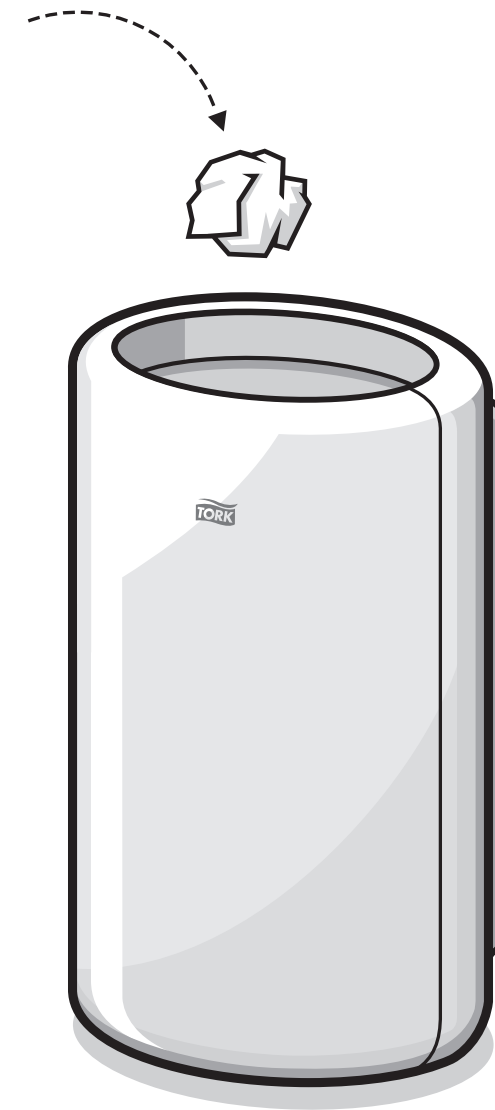

 **essity** Manufactured by Essity Hygiene and Health AB
SE-40503 Göteborg, Sweden
Visiting address: Mölnåls Bro 2, Mölndal
www.essity.com, www.torkglobal.com
Made in Germany
Patents/Brevets/Patentes: www.essity.com/patents
Essity UK Limited
Southfields Road, Dunstable,
Bedfordshire, LU6 3EJ, UK

www.torkglobal.com



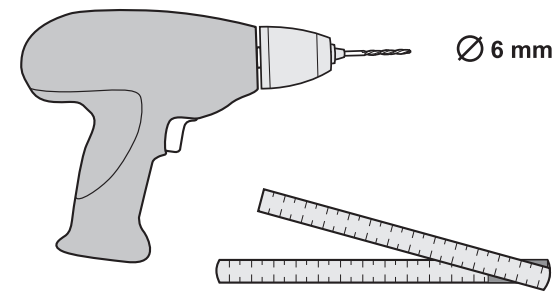
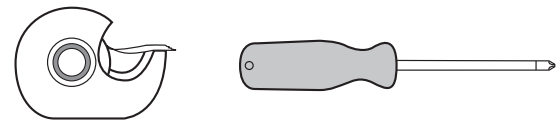
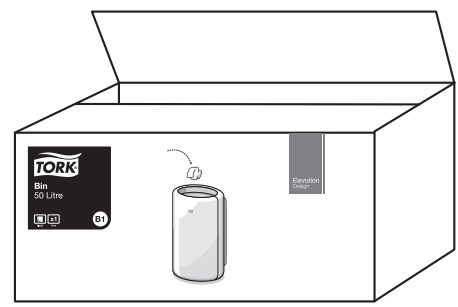

5.

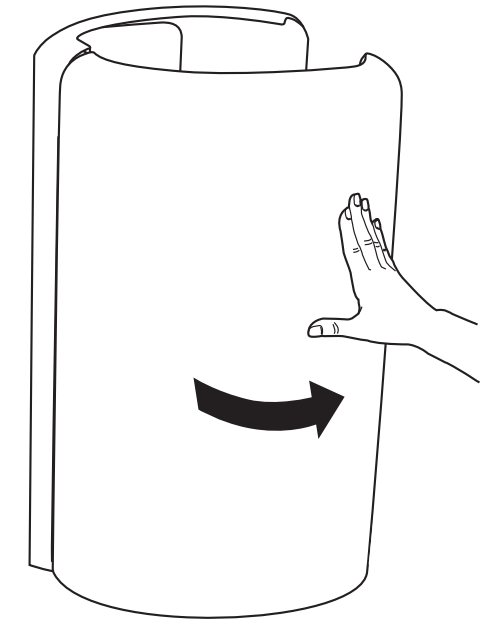

6.

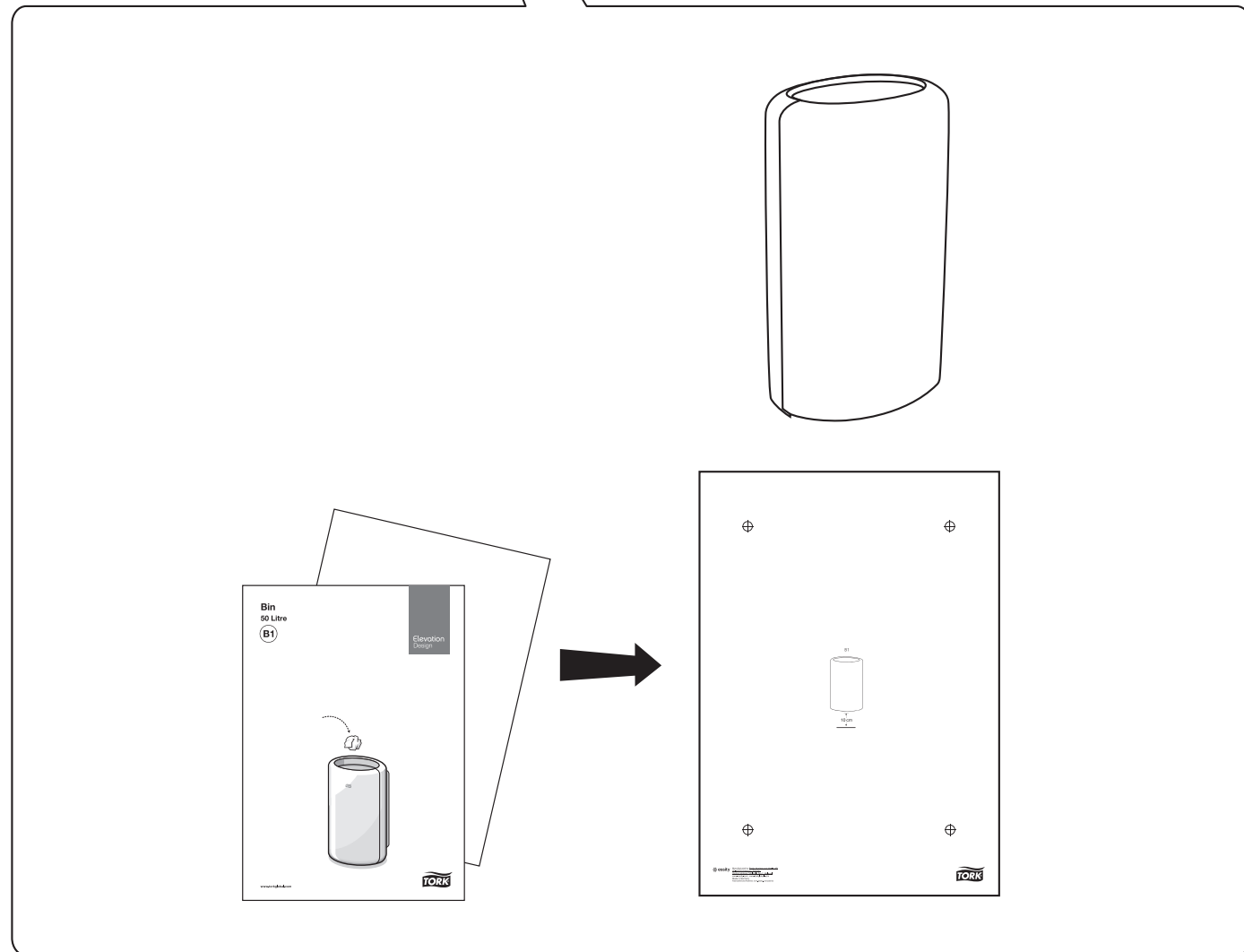
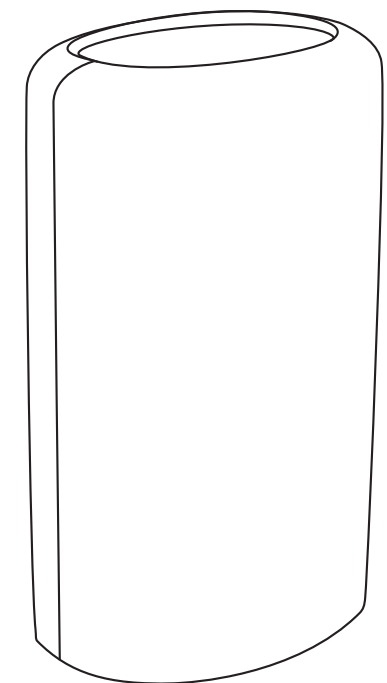

2.

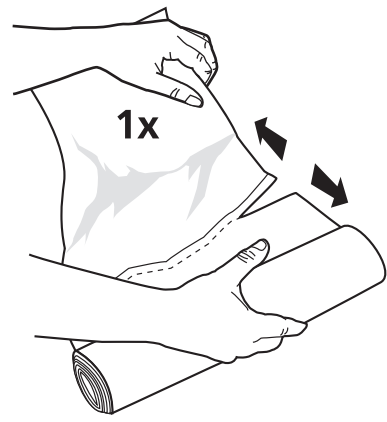

3.

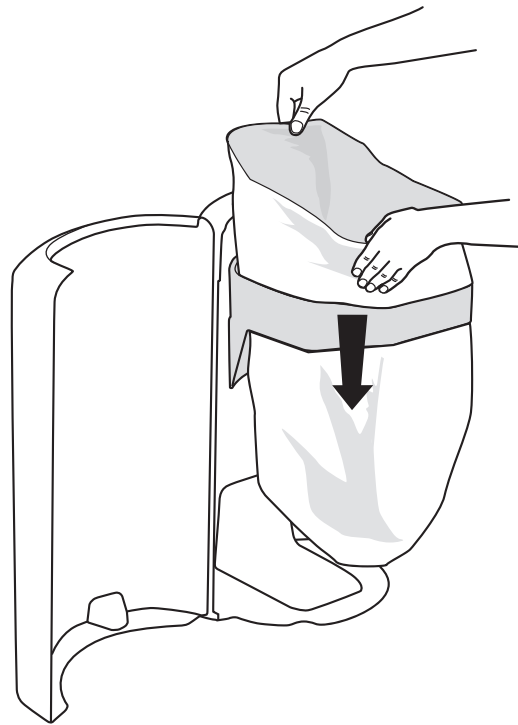

4.

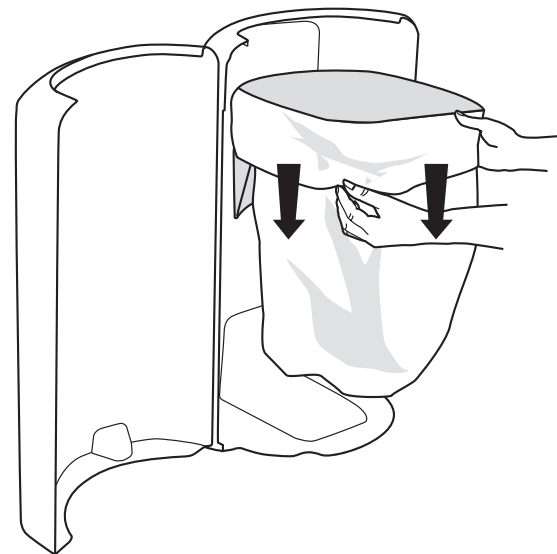

A

B

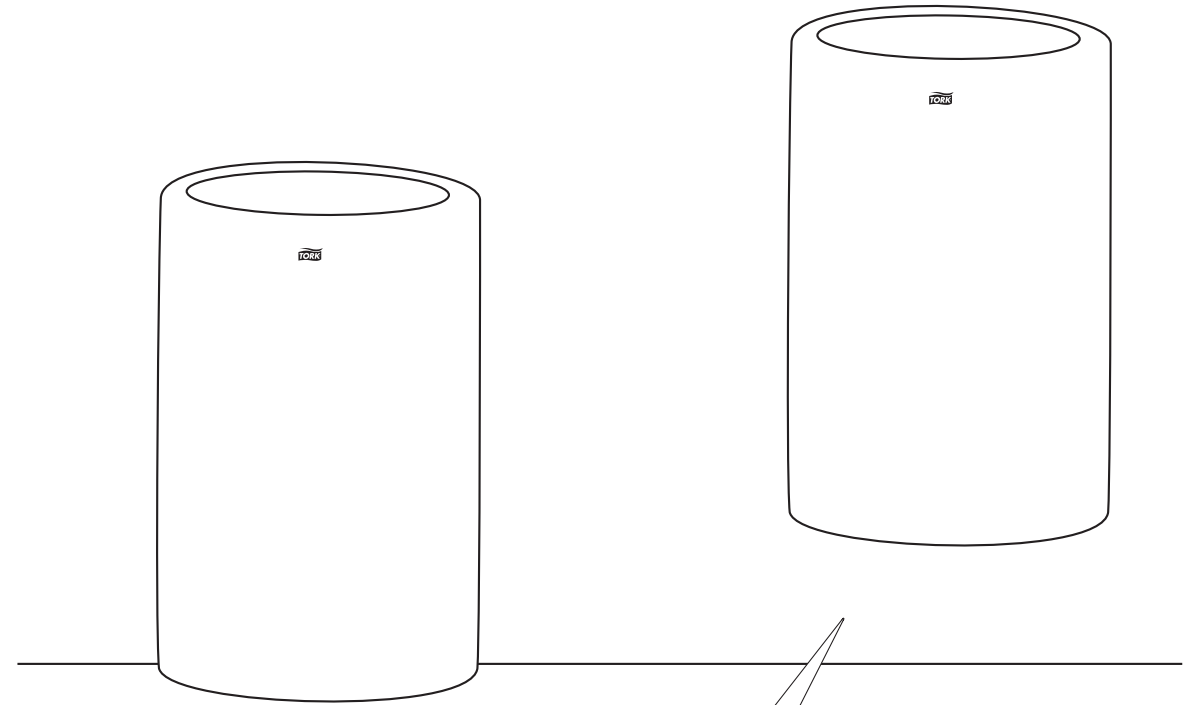

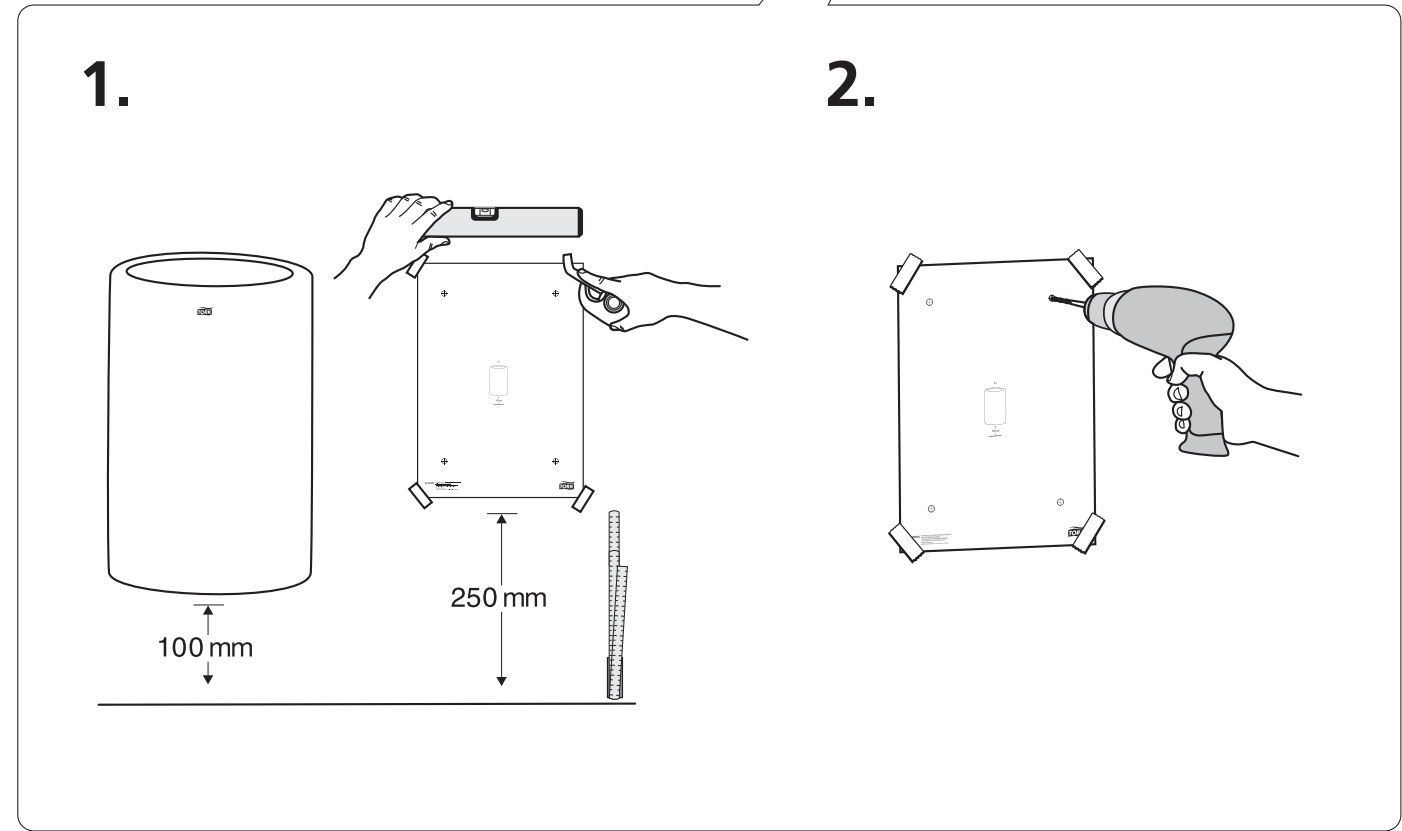

1.

2.



3.

-  x 4
-  x 4

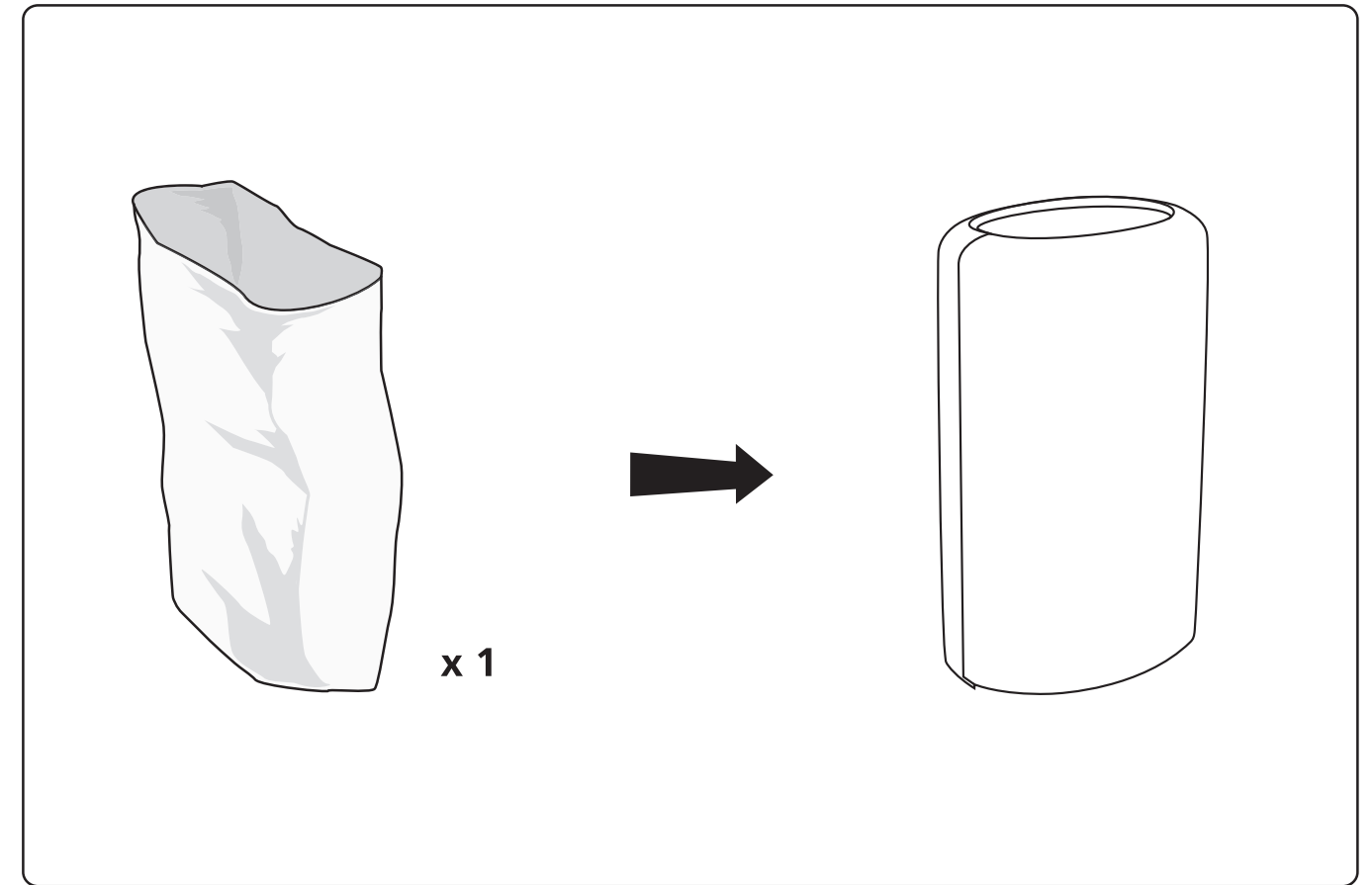
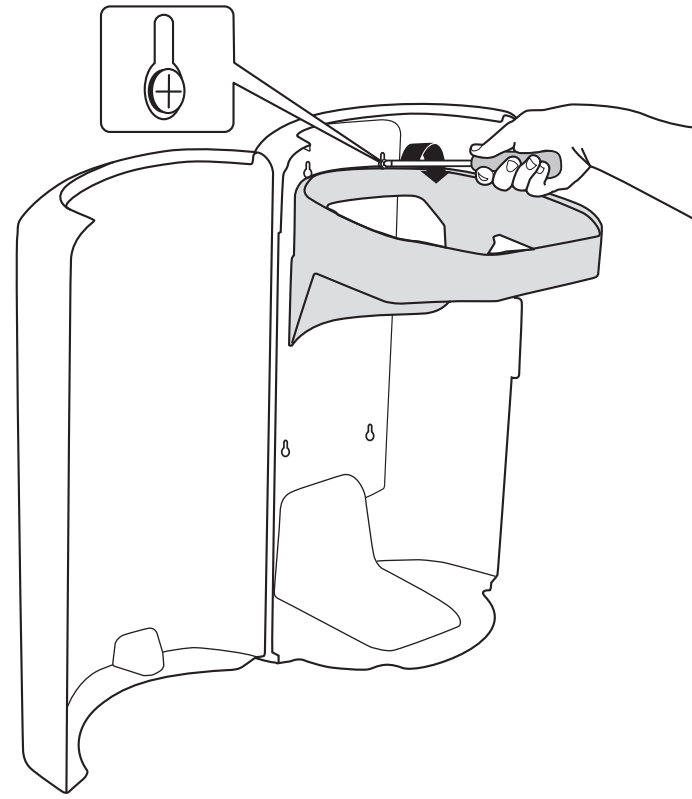

1.

4.

